



CRONO 7

Wireless

Weekly digital
chronothermostat

IE

**Instructions and
warning book**



Dear Client,

*Our compliments for having chosen a top-quality **Immergas** product, able to assure well-being and safety for a long period of time.*

*As an **Immergas customer** you can also count on a qualified after-sales service, prepared and updated to guarantee constant efficiency of your "Chronothermostat".*

*We would like to supply you with some important indications, the respect of which will confirm your satisfaction with the **Immergas** product:*

- *Read the following pages carefully: you will obtain useful suggestions regarding the correct use of the appliance.*
- *For any interventions or routine maintenance contact "**Immergas Authorised Centres**": they have original spare parts and specific preparation.*

DECLARATION OF CONFORMITY

For the purpose and effect of the 2006/95/CE Low Voltage Directive, 2004/108/CE EMC Directive and 1999/05/EEC clause 3.2 R&TTE Directive.

The Manufacturer: Immergas S.p.A. v. Cisa Ligure n° 95 42041 Brescello (RE)

DECLARES THAT: The Immergas chronothermostat: **CRONO 7 Wireless** is in compliance with the same European Community Directives

Mauro Guareschi

Research & Development Director

Signature:

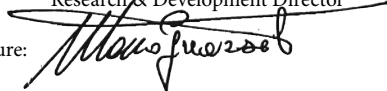

How to use the instruction book.....	4
Foreword	4
General recommendations.....	4
Case cleaning	5
1. Installation	6
1.1 Installation recommendations.	6
1.2 Installation operations.	6
2. Description of Controls	11
2.1 Description of reception Base in radiofrequency.	11
2.2 Meaning of flashing LEDs.	11
2.3 Description of CRONO 7	12
3. Description of display	13
3.1 Back-lighting	14
4. Start-up.....	15
4.1 Programming current day and time.....	15
4.2 Selection of functioning mode.....	15
5. Winter mode functions	17
5.1 Manual functioning.....	17
5.2 Automatic functioning.....	18
5.3 Forced automatic functioning.....	18
5.4 Room anti-freeze function.	19
6. Chiller control mode functions.....	20
6.1 Manual functioning.....	20
6.2 Automatic functioning.....	21
6.3 Forced automatic functioning.....	21
7. CRONO 7 programming.....	22
7.1 Setting comfort and economy room temperature.....	22
7.2 Programming functioning time.....	23
8. Diagnostics and errors	24
8.1 Errors.....	24
8.2 Diagnostics.	24
9. Special functions.....	25
9.1 INFORMATION.....	25
9.2 LANGUAGE (language selection).....	25
9.3 CHILLER.....	25
9.4 REGOLAZ (Management of regulation parameter)...25	
9.5 VACANZ (holiday program).	26
9.6 REMOTE (telephone control).....	26
9.7 CODE.....	26
9.8 Reset of CRONO 7.....	26
10. Functions protected by code (CODE).....	27
10.1 AMB (room probe - On / Off or Modulating functioning mode).	27
10.2 ANTIGL (anti-freeze level).	27
10.3 MANUTZ (programmed maintenance).....	27
10.4 HYSTERESIS.....	28
10.5 ASSOCIATION PROCEDURE IN RF.....	28
10.6 RF DISASSOCIATION PROCEDURE.....	28
11. CRONO 7 Base test procedure.....	29
12. Replace the batteries.....	29
12.1 CRONO 7 Base	29
12.2 CRONO 7	29
13. Technical characteristics	30
13.1 CRONO 7 Base	30
13.2 CRONO 7	30
13.3 Product specifications.	31
14. Factory setting.....	31

HOW TO USE THE INSTRUCTION BOOK

The instruction book has been divided into 3 main parts:

in the first, for the installer, the assembly and connection phases of the remote control with the boiler are described;

in the second, all functioning program customisation phases are described;

in the third and last part, all operations for displaying and keeping system functioning under control are described.

FOREWORD

The “**CRONO 7 Wireless**” (**Digital weekly chrono-thermostat**) has been designed to guarantee ideal temperature conditions at any time of the day and night for each individual day of the week.

Only a few minutes are required for installation: the Base controlled in radiofrequency and powered by battery, is in fact, connected to the appliance with only 2 cables, through which performs the required air-conditioning. The chrono-thermostat however, also with independent battery power supply, must only be fixed to the wall and does not require any electric connection, if not a radiofrequency acknowledgement with its own Base. On completion of installation it is ready to function thanks to the pre-set program inside. The customer can modify the basic program

according to requirements.

Programming of the “CRONO 7” is extremely easy and a wide display allows constant control of all values set.

GENERAL RECOMMENDATIONS

This manual has been drawn-up for: **the Installer and the User**.

- Carefully read the warnings contained in this document as they are required to indicate the use of the CRONO 7 envisioned by the design hypothesis, the technical features, the installation, assembly, programming, adjustment and use instructions.
- The system must be in compliance with the IEC Standards in force.
- The instruction manual must be considered a part of the CRONO 7 and must be “**kept for future reference**”.
- After having removed the packaging, check the integrity of the CRONO 7 and its base. If in doubt, do not use it and contact the **Dealer or Manufacturer**.
- The CRONO 7 is destined only for the use for which it has been expressly designed. Any other use must be considered improper and therefore dangerous.

- Our products are realised in compliance with the Safety Standards in force, it is therefore recommended to use all those devices or attentions in a way that injury/damage is not caused to persons or objects.
- Do not remove parts of the CRONO 7 when it is functioning.
- Do not use the CRONO 7 exposed to heat sources or under the scorching sun.
- Periodically check the batteries in case of dead batteries can run the risk of a permanent request at the appliance until the next replacement of the batteries.
- The manufacture is relieved from any liability in the following cases:
 - a) Incorrect installation.
 - b) Boiler functioning defects to which the chronothermostat is applied.
 - c) Unauthorised modifications or interventions.
 - d) Total or partial failure to comply with instructions.
 - e) Exceptional events etc.

CASE CLEANING

To clean the case of CRONO 7 use damp cloths. Never use abrasive or powder detergents.

WARNING

Immergas reserves the right to make improvements and modifications to details and accessories, excepting the essential features of the model described and illustrated herein.

1. INSTALLATION

1.1 Installation recommendations.

The CRONO 7, including the relative cables and connections to the boiler, must be installed by specialised staff. On the free initial check of the boiler, when the CRONO 7 is inserted into the system, the Immergas authorised after-sales centre checks the connection to the generator terminal board and adjusts functioning. The free check just of the CRONO 7 is not envisioned by the Immergas authorised after-sales centre if requested successively to the start phase of the boiler warranty.

Important: laying of the CRONO 7 base cables is excluded from the free boiler checks; it is the responsibility of the installer company.

Attention: in order for the chrono-thermostat to operate correctly you must select winter mode on the control panel of the boiler.

N.B.: follow the installation sequence, first installing the Base and then the CRONO 7.

1.2 Installation operations.

1) Separate the fixing bottom from the lid of the CRONO 7 Base using a screwdriver as a lever in the relevant recess (fig. 1). Pull the lid manually outwards to separate it from the bottom.

2) Install the CRONO 7 Base bottom using the holes made in the rear of the same directly onto the wall or onto a recess box using the relative supplied screws (fig.2).

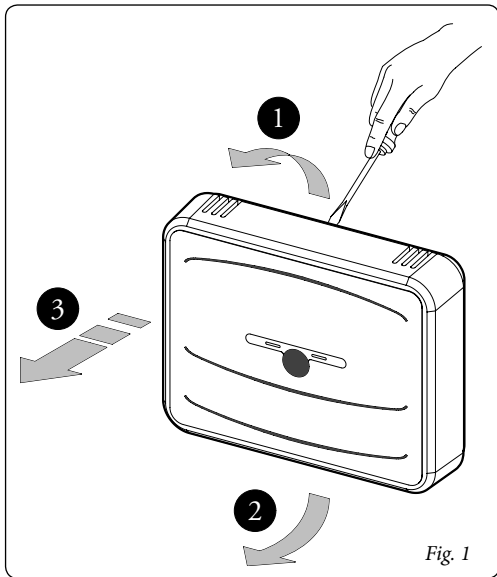
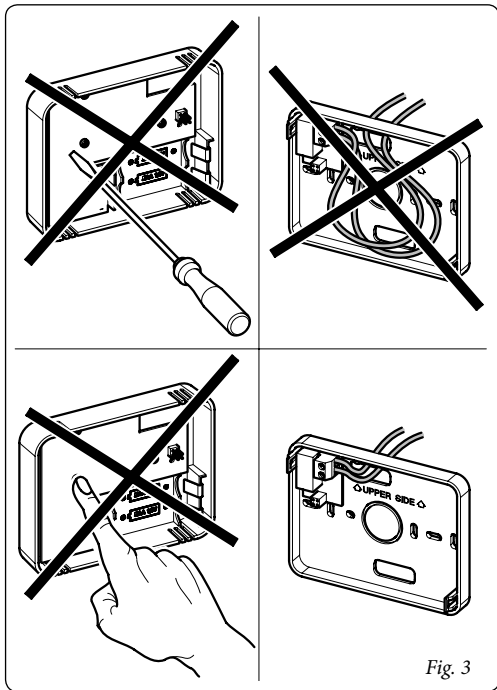
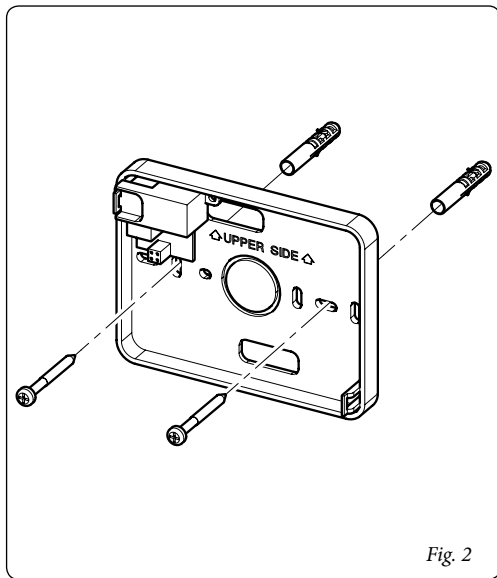

Fig. 1

N.B.: Use is recommended in non-critical electro-magnetic places and in structures realised with materials that are not mainly metal or shielding. During installation, pay attention as indicated in fig. 3.



- 3) To make the electrical connections (fig. 4) **do not operate when the boiler is live. The connection must be made at the clamps envisioned for the connection to the room thermostat.**

Note: refer to the electrical connections stated in the boiler instruction book.

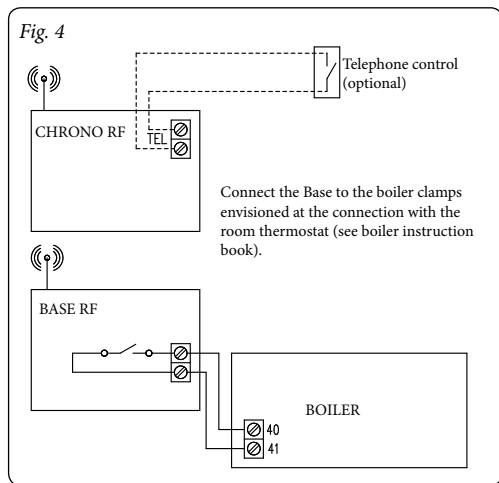

The connection to the boiler is made using two wires (fig. 5) with minimum section of 0.50 mm² and maximum of 1.5 mm².

N.B: for correct installation prepare a dedicated line for the connection of the CRONO 7 according to the Standards in force regarding electrical systems.

- 4) Insert 2 1.5V AA batteries (not supplied) into the relevant housing (fig. 5).
- 5) Fix the CRONO 7 Base lid to the support bottom, engaging it using pressure (fig. 5).

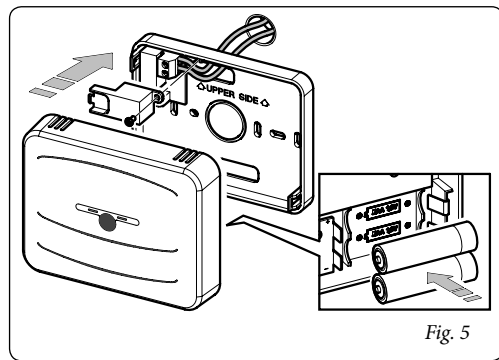

N.B.: during lid closure, make sure that it is correctly aligned with the bottom.

- 6) Separate the fixing template from the body of the CRONO 7 using a screwdriver as a lever in the relevant recess (fig. 8). Install the CRONO 7 away from heat sources and in a suitable position to detect the room temperature correctly (fig. 6 and 7).
- 7) Install the CRONO 7 using the holes made in the rear of the same directly onto the wall using the relative supplied screws (fig.8).
- 8) Fix the body of the CRONO 7 to the support template, engaging it with pressure and using the the two screws provided (fig. 8).
- 9) Insert 2 1.5V AA batteries (not supplied) into the relevant housing (fig. 8) and close the battery compartment.
- 10) The Base and the CRONO 7 are associated to each other in the inspection phase in the factory. Therefore, a further association in radiofrequency procedure is not necessary.

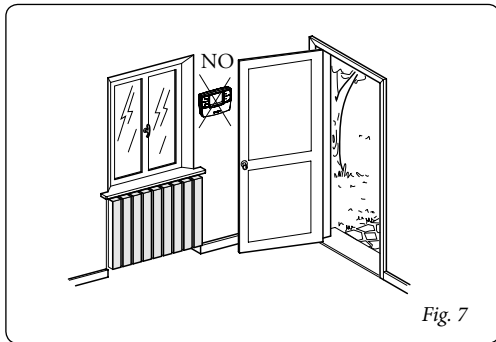
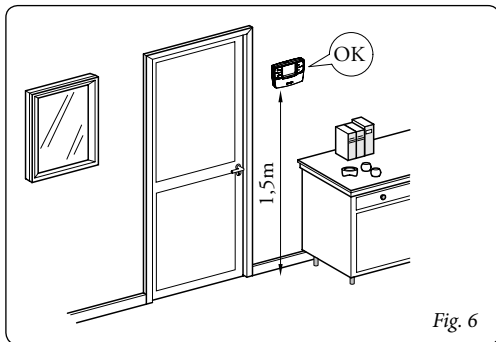

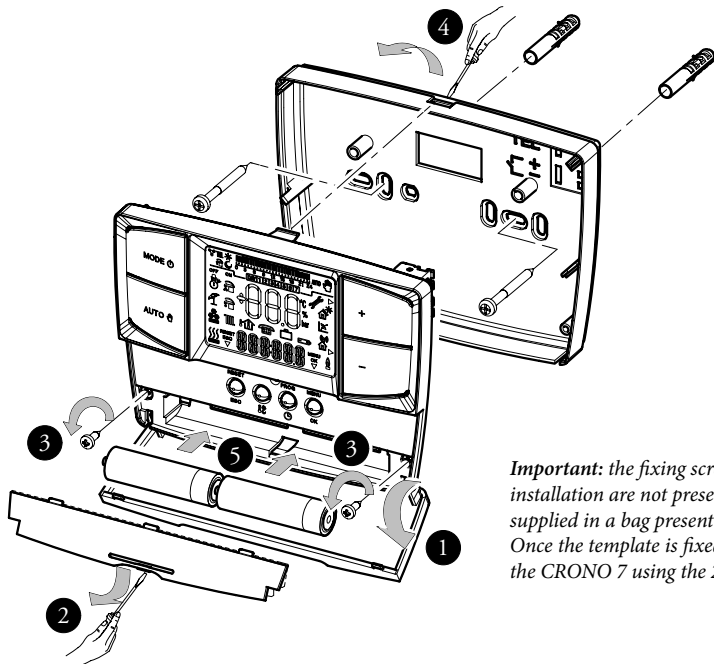

Important: the fixing screws (action n° 3) on first installation are not present on the CRONO 7, but are supplied in a bag present in the packaging box. Once the template is fixed to the wall, fix the body of the CRONO 7 using the 2 screws.

Fig. 8

2. DESCRIPTION OF CONTROLS

2.1 Description of reception Base in radiofrequency.

The reception base in radiofrequency is a battery powered device (2 x 1.5V AA), which allows the control of a central heating unit with programs, settings and modes determined by the associated CRONO 7.

2.2 Meaning of flashing LEDs.

The right LED (ref. 3 fig. 9) indicates the receipt or stand-by for reception of the CRONO 7 signal in normal functioning

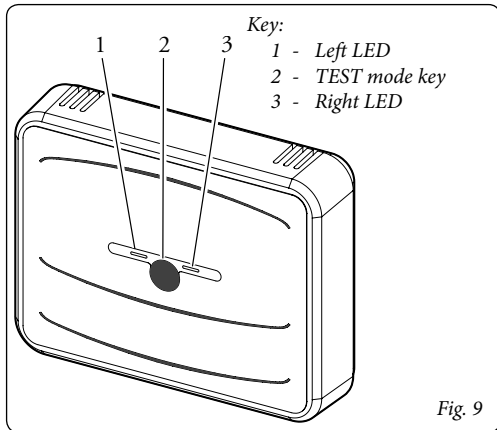

Fig. 9

mode while the one on the left (ref. 1 fig. 9) indicates the operational status of the device. As the system is battery powered, the LEDs remain off for most of the time.

The following signals take place once a minute:

- One long single flash of the right LED (ref. 3 fig. 9) indicates no reception of a valid packet from associated CRONO 7. In this case, the RF communications are absent; this status indicates an anomaly or the absence of an associated and functioning CRONO 7;
- One brief single flash of the right LED (ref. 3 fig. 9) indicates reception of a valid packet from associated CRONO 7. In this case, the RF communications are present and operating correctly (except for anomalies indicated by the CRONO 7). This is the normal functioning status in the presence of an associated and functioning CRONO 7;

The continuous flashing of the left LED (ref. 1 fig. 9) for 10 seconds indicates an association/installation stand-by phase of the Base at a CRONO 7, which requests association;

Switch-on of the left LED for 2 seconds (ref. 1 fig. 9) indicates the entry to TEST mode (see par. 11); switch-on is guaranteed exclusively if the Base and the associated CRONO 7 are synchronised at that moment. If this is not the case, the left LED (ref. 1 fig. 9) will remain off.

2.3 Description of CRONO 7

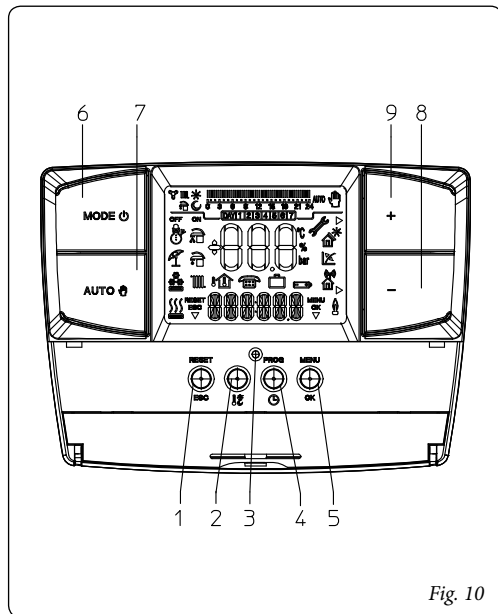















Fig. 10

Ref.	Description
1	“Reset”/“Esc” escape parameter or return to previous menu button (programming mode)
2	Comfort and economy room temperature setting button
3	Reset button for restarting CRONO 7 in event of anomaly of the same.
4	Access button to time, day and timer
5	Access button to the programming/confirm parameters menu
6	General selection button: Off, Stand-by/anti-freeze, Winter
7	Manual, automatic functioning button
8	Temperature decrease button
9	Temperature increase button

3. DESCRIPTION OF DISPLAY

Symbol	Description
	Winter - room central heating functions are enabled
	Cooling - the cooling function is enabled
	Request for room central heating or cooling from CRONO 7
RESET ESC ▽	Description of functioning of the button (1 fig. 10) - Reset, or esc
	Displays room temperature and numerical data
	Internal temperature display
	Function activation from remote
	Functioning with holiday timer program
	Batteries flat

Symbol	Description
	Description of functioning state in use
	CRONO 7 anomaly presence symbol
▷	Indicates that it is possible to modify a parameter via the two buttons (8 and 9 fig. 10)
	Indicates the association between the Base and CRONO 7
MENU OK ▽	Description of functioning of the button (5 fig. 10) - Menu or Ok
	Symbols that identify the functioning mode in the hourly programming*
	Time bar that identifies the functioning period at “comfort” and “economy” temperature on the basis of the type of programming (cooling, central heating)
AUTO	Functioning with automatic program.

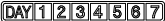
Symbol	Description
	Functioning with manual program
	Display of days of the week

(*): the function () is not available on Crono 7

N.B.: Some icons can assume different meanings according to the context, see the successive paragraphs to identify the functions activated by the presence of several icons at the same time.

3.1 Back-lighting.

By pressing any button the display lightens for a set time.

4. START-UP

4.1 Programming current day and time.

Switch the chrono-thermostat on by turning the main selector onto one of the functions available.

Press the **PROG** button to enter time and current time mode and press the **OK** button to modify the settings.

On entering the programming mode, the time starts to flash.

Modify the hour and minutes by pressing the + / - buttons and the **OK** button to confirm. Select the day of the week and confirm using the **OK** button.

Once regulation has been completed, press the **ESC** button to escape the regulation mode.

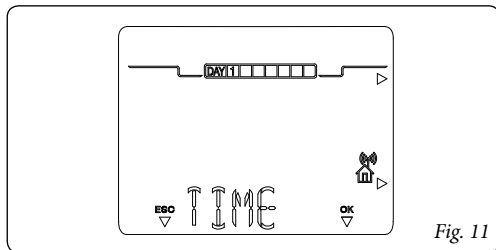

Fig. 11

4.2 Selection of functioning mode

According to the functioning mode selected, the CRONO 7 performs the requests of the user, displaying the results on the display.

By pressing the main selector button (ref. 6 fig. 10) the following functions can be selected:

- Off;
- Anti-freeze;
- Winter / Chiller.

Note: the room anti-freeze function is active in the anti-freeze and winter functioning modes.

- **Off mode.** The room anti-freeze function is not guaranteed in this mode (the boiler anti-freeze function remains active). The CRONO 7 is off but remains powered and therefore the times and programs remain memorised.

- **Stand-by/anti-freeze mode** (*). In this mode, the boiler can only function in the event of anti-freeze request. In this state, the day, current time, any functioning anomalies and the room temperature are displayed (fig. 12).
- **Winter/chiller mode.**
 - **Winter mode** (⊕). In winter mode the boiler is enabled for room central heating. In winter mode the CRONO 7 can function in automatic or manual mode. For the description of functioning see chapter 5. The display shows the day and current time, the room temperature and the hour bar with the daily programming of the central heating timer along with the relative symbols (fig. 13).
 - **Chiller control mode** (⊖). It is possible to enable CRONO 7 on control of a chiller for cooling environments (for enabling of this function, see par. 9.3). In "cooling" mode the CRONO 7 can function in automatic or manual mode. For the description of functioning see chapter 6. The display shows the day and current time, the room temperature and the hour bar with the daily programming of the cooling timer along with the relative symbols (fig. 14).

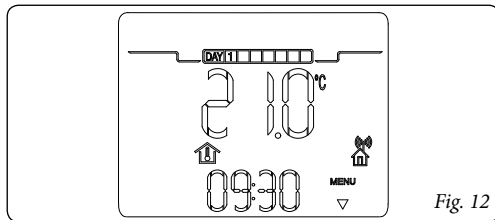

Fig. 12

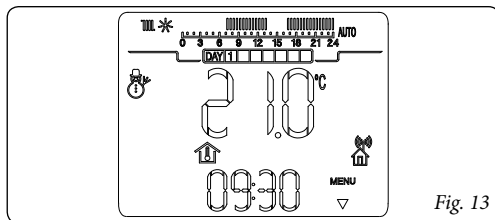

Fig. 13

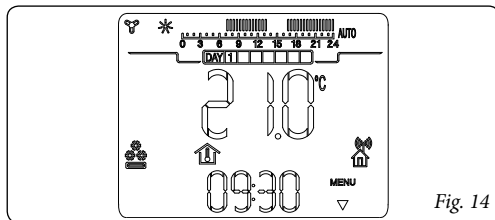

Fig. 14

5. WINTER MODE FUNCTIONS

With the CRONO 7 in winter mode (☸), the room central heating function is enabled. Two main functioning modes can be selected for room central heating: automatic or manual. Plus a forced automatic timed program.

- Manual (☸): the room temperature is kept constant at the value set by the user every time, according to requirements.
- Automatic (AUTO): the room temperature is regulated on two levels (comfort and economy) during the day via a program set by the user.
- Forced automatic (☸ flashing): the room temperature is modified momentarily with respect to automatic functioning until the successive passage between comfort and energy mode of the automatic program set.

5.1 Manual functioning.

By pressing the AUTO ☸ button, pass alternately from automatic to manual functioning.

Once manual functioning mode is set, the ☸ icon switches on on the display (fig. 15).

To set the desired room temperature, just press the + / - buttons and the room temperature set will appear on the display (fig. 16). Just wait a few seconds to confirm the new value.

In manual functioning mode it is possible to select any room temperature from +10°C to +35°C, which will be kept constant until new adjustments or selection of a different functioning mode.

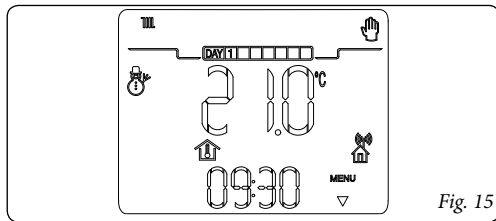

Fig. 15

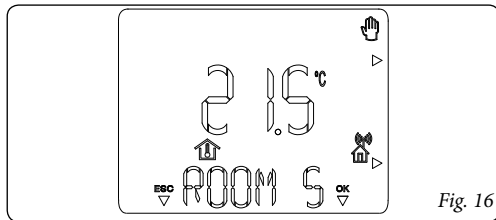



Fig. 16

5.2 Automatic functioning.

The CRONO 7 allows automatic functioning, in which a time program manages the room temperature during the hours of the day.

The desired room temperature can be adjusted onto two independent levels: comfort (☀) and economy (☾) via the  button, whose distribution throughout the day or the week is managed by hourly programming.

Press the **AUTO**  button until the icon switches-on on the **AUTO** display.

The CRONO 7 is factory-set with a standard program stated in the table that follows. If this should not satisfy requirements, it is possible to modify it as described in the chapter relative to programming.

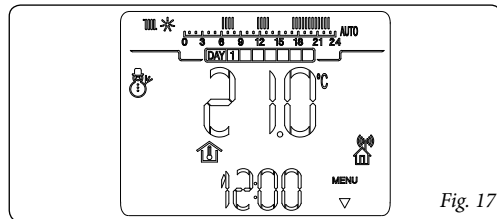

Fig. 17





Days	 ☾ 16°C	 ☀ 20°C
Mon - Fri (Day 1 - 5)	from 23 to 6 from 8 to 11 from 13 to 17	from 6 to 8 from 11 to 13 from 17 to 23
Sat - Sun (Day 6 - 7)	from 23 to 7	from 7 to 23

Fig. 18

Note: the system is designed to function on comfort and economy temperature levels depending on the hour program set. Therefore also during functioning on economy level, if the room temperature measured is below that set, the boiler can ignite.

5.3 Forced automatic functioning.

If in automatic functioning mode () the room temperature is modified by pressing the + / - buttons, the forced automatic functioning mode is activated (displayed by the switch-on of the flashing  symbol). In this mode, the room temperature will be regulated to the value set until the next switch-on or switch-off phase of the automatic program set. The forced automatic function can be interrupted by simply pressing the **AUTO**  button.

5.4 Room anti-freeze function.

The anti-freeze function has maximum priority with respect to other settings. When the room temperature drops below 5°C (adjustable, see special functions chapter) a central heating request is made. This situation remains active until there is a variation in room temperature of 0.6°C equal to 5.6°C measured in the room where the CRONO 7 remote control is positioned.

6. CHILLER CONTROL MODE FUNCTIONS

With the CRONO 7 in chiller control mode (❄️), the room central heating function is enabled.

Important: this function can only be used with direct connection to a fan coil in alternative at the boiler connection.

Two main functioning modes can be selected: automatic or manual, plus a forced automatic timed program.

- Manual (👤): the room temperature is kept constant at the value set by the user every time, according to requirements.
- Automatic (AUTO): the room temperature is regulated on two levels (comfort and economy) during the day via a program set by the user.
- Forced automatic (👤 flashing): the room temperature is modified momentarily with respect to automatic functioning until the successive passage between comfort and energy mode of the automatic program set.

6.1 Manual functioning.

By pressing the AUTO 👤 button, pass alternately from automatic to manual functioning.

Once manual functioning mode is set, the 👤 icon switches on the display (fig. 19).

To set the desired room temperature, just press the + / - buttons and the room temperature set will appear on the display (fig. 20). Just wait a few seconds to confirm the new value. In manual functioning mode it is possible to select any room temperature from +15°C to +40°C, which will be kept constant until new adjustments or selection of a different functioning mode.

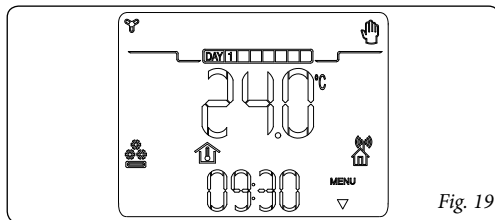

Fig. 19

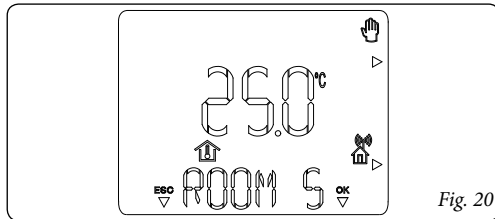



Fig. 20

6.2 Automatic functioning.

The CRONO 7 allows automatic functioning, in which a time program manages the room temperature during the hours of the day.

The desired room temperature can be adjusted onto two independent levels: comfort (☼) and economy (☾) via the  button, whose distribution throughout the day or the week is managed by hourly programming.

Press the **AUTO**  button until the icon switches-on on the **AUTO** display.

The CRONO 7 is factory-set with a standard program stated in the table that follows. If this should not satisfy requirements, it is possible to modify it as described in the chapter relative to programming.

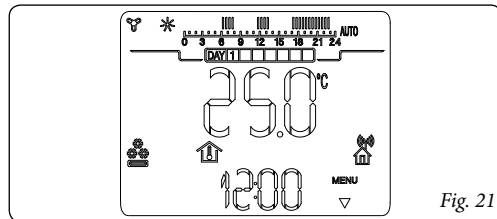

Fig. 21





Days	 40°C	 25°C
Mon - Fri (Day 1 - 5)	from 23 to 11 from 13 to 17	from 11 to 13 from 17 to 23
Sat - Sun (Day 6 - 7)	from 23 to 13	from 13 to 23

Fig. 22

Note: the system is designed to function on comfort and economy temperature levels depending on the hour program set. Therefore also during functioning in economy temperature conditions, if the room temperature measured is above that set, the chiller can switch-on.

6.3 Forced automatic functioning.

If in automatic functioning mode () the room temperature is modified by pressing the + / - buttons, the forced automatic functioning mode is activated (displayed by the switch-on of the flashing  symbol). In this mode, the room temperature will be regulated to the value set until the next switch-on or switch-off phase of the automatic program set. The forced automatic function can be interrupted by simply pressing the **AUTO**  button.

7. CRONO 7 PROGRAMMING

Programming of the CRONO 7 allows to set/modify the following parameters:

- comfort and economy temperature levels (different for the “central heating” and “cooling” modes);
- daily/weekly functioning time program (different for the “central heating” and “cooling” modes).

7.1 Setting comfort and economy room temperature.

The two temperatures are different depending whether they are in "winter" or "chiller" mode.

By pressing the  button, the “comfort” (fig. 23) and “economy” (fig. 24) temperatures are displayed alternately.

To regulate both parameters, just press the + / - buttons to regulate the temperature according to requirements.

To confirm the new temperature, press the OK button, to exit without saving the modifications, press the ESC button.

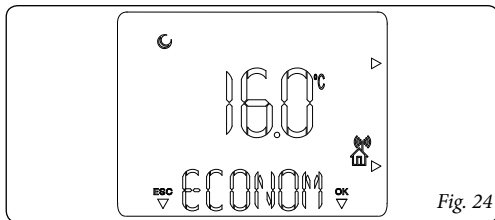
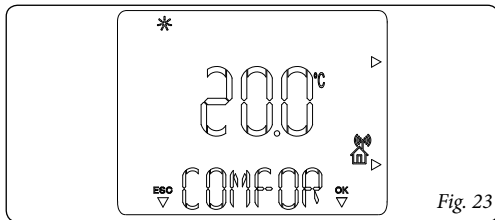

7.2 Programming functioning time.

By pressing the **PROG** button, it is possible to enter the time periods programming window for programming the room temperatures (as well as setting the current time and day).

By pressing the + / - buttons, the items that can be set in the menu are displayed alternately.

There are, in fact, two types of program:

- **PR RIS:** room central heating program
- **PR RAF:** room cooling program

By following the points described below, it is possible to create or modify the time program selected.

- 1) Press the **PROG** button, select the program to modify by pressing the + / - buttons, after which confirm by pressing the **OK** button.
- 2) Select the day or group of days by pressing the + / - buttons and confirm the selection by pressing the **OK** button:
 - Monday, Tuesday, Wednesday... Sunday (individual day)
 - Mon - Fri (from Monday to Friday)
 - Sat - Sun (from Saturday to Sunday)
 - Mon - Sat (from Monday to Saturday)
 - Mon - Sun (from Monday to Sunday)

- 3) Set the functioning times with comfort and economy temperature. Within the 24 hours it is possible to define a maximum of 4 time periods with Comfort temperature, each of which is characterised by a switch-on time and a switch-off time.

The minimum variation of the switch-on and switch-off time is 30 minutes.

- 4) Set the first functioning period with comfort temperature (ON 1) indicated at the top and the switch-on time at the bottom. Press the + / - buttons to modify the switch-on time and press the **OK** button to memorise. At this point, pass to the next functioning period with comfort temperature (OFF) indicated at the top and the switch-off time at the bottom. Press the + / - buttons to modify the switch-off time and press the **OK** button to memorise.

When the first phase has been defined, pass automatically to the next functioning phases at comfort and economy temperature in order to program. This means repeating the points described previously up to phase 4.

The sequences of the On and Off states must always be sequential. For example, it is not possible to set "OFF 2" at 13.30 and "ON 3" at 11.00.

Once the day or group of days have been programmed, proceed in the same way for the remaining days and the remaining programs.

N.B.: if only 3 switch-on times are used, set the fourth with switch-on/off time at 24.

N.B.: in automatic functioning conditions (AUTO) the display will show the 24 hour bar indicating the different time phases with Comfort or Economy temperature



The presence of the hyphen on the time bar corresponds to functioning in Comfort mode.

8. DIAGNOSTICS AND ERRORS

8.1 Errors.

CRONO 7 controls its own functioning state, signalling any malfunctions.

Code	Description
ERR>TP	Error in reading the room temperature or value measured off scale (below 0°C or over 50°C)

8.2 Diagnostics.

The wireless communication is identified with the symbol . The different communication modes are listed below.

Symbol	Description
	
Absent	Disassociated devices
Flashing	Associated devices with communication error
Present	Associated and communicating devices

9. SPECIAL FUNCTIONS

By pressing the **MENU** button, a list of options is accessed that allows to customise functioning of the CRONO 7, according to the specific necessities.

To scroll the list, press the + / - buttons and press the **OK** button to select the desired function.

9.1 INFORMATION

Press the **MENU** button and scroll the options present until “INFO” appears. By pressing the **OK** button, access a menu that allows to verify the functioning state of the CRONO 7. If a determined value is not present “-” will be displayed.

Press the +/- button repeatedly to scroll the list.

To go back to normal functioning mode, press the **ESC** button or wait 60 seconds.

The parameters that can be displayed are listed below:

- **MANUTZ**: Days remaining before periodic maintenance.
- **FW VERS**: The display shows the firmware version of the CRONO 7.

9.2 LANGUAGE (language selection).

It is possible to select the functioning language of the CRONO 7. It is possible to select from Italian (ITA as per standard) and English (ENG).

N.B.: The CRONO 7 is factory set in Italian, proceed as follows to pass to English:

- Press the **MENU** button.
- Scroll the list of parameters, pressing the + / - buttons until reaching “LINGUA”.
- Press the **OK** button to select the function.
- Select “ENG” by pressing the + / - buttons.
- Confirm the selection using the **OK** button.

9.3 CHILLER.

Allows to set the CRONO 7 for the management of a chiller for cooling rooms:

- **ON**: cooling functioning;
- **OFF**: winter functioning.

9.4 REGOLAZ (Management of regulation parameter).

Allows to customise the functioning parameters of the CRONO 7:

- **DIMENS** (dimension and building inertia), adjustable from 1 to 20, as per standard set on 10. It establishes the reaction speed of the system depending on the type of system present.

For example:

Value	System type
5	system with little heat inertia
10	system with normal dimensions with radiators
20	system with a lot of heat inertia (e.g. floor-standing system)

9.5 VACANZ (holiday program).

From winter functioning mode it is possible to define a number of days (from 1 to 99) during which the system deactivates the room central heating function.

The value is decreased every midnight in the day change. At the end of the days set (the meter reaches 0) the previously active functions are restored. The activation of the holiday function is indicated by the flashing of the  icon and the count of the days remaining.

The holiday function can be deactivated by pressing the **AUTO**  button.

In the event of remote activation from telephone control, the boiler is activated with the settings of the telephone control, omitting the Holiday program.

N.B.: the room anti-freeze function is however guaranteed also in holiday mode.

9.6 REMOTE (telephone control).

Allows to set the functioning of the CRONO 7 in a way that, in the event of remote activation, it functions with the automatic time program if set at AUTO. Vice versa, it functions at continuous comfort temperature (without time program) if set at ON.

In the event of activation, it displays the flashing  icon.

Warning: when the CRONO 7 is set on chiller function  or Off mode remote activation is not available.

9.7 CODE.

To use this function, see the “Functions protected by code” chapter.

9.8 Reset of CRONO 7.

It is possible to perform 2 types of CRONO 7 reset:

- By pressing the RESET key (ref. 3 fig. 8) a system reset is performed without modification of the time and weekly programming.
- By pressing the RESET key (ref. 3 fig.8) and the ESC key simultaneously (ref. 1 fig. 8) the factory conditions are reset.

10. FUNCTIONS PROTECTED BY CODE (CODE).

They are advanced character settings (reserved for an enabled technician), a four character code must be entered in order to access them (code: 1122).

Press the **MENU** button and scroll the options present until "CODE" appears, press the **OK** button and insert the code by selecting the characters using the + / - buttons and confirming them by pressing the **OK** button.

After which it is possible to display and modify the following functions.

10.1 AMB (room probe - On / Off or Modulating functioning mode).

Allows to activate or deactivate the room probe present in CRONO 7. On the basis of the parameter setting, it will be possible to regulate the following options:

- AMB: ON (standard value); it is possible to select a correction factor of the room probe reading and change the modulating function.
- AMB CR: room probe reading correction, the room probe range reading can be corrected within a range of + 3.0 - 3.0°C.
- **MODUL (On / Off or Modulating functioning):** allows to set functioning of the CRONO 7 On/Off or Modulating. Set at ON the Modulating function is

activated, which guarantees greater control precision of the room temperature and therefore improved comfort. Boiler activation will depend on the room temperature but also on the heat inertia of the system (set via the "DIMENS" parameter). As a consequence there will be boiler on/off cycles in which the switch-on cycle is longer, the lower the room temperature, with respect to that set. Set at OFF, the Modulating function is deactivated. The request will be satisfied only depending on the room temperature.

- AMB: OFF, the system will not function, regulating the room temperature but only depending on the time program set.

10.2 ANTIGL (anti-freeze level).

Allows to set the room temperature for activation of the anti-freeze function. Can be regulated from 0°C to 10°C and is set at 5°C as standard.

10.3 MANUTZ (programmed maintenance).

Sets the interval for periodic maintenance (can be set from 6 to 24 months or "Off"). When the period has been set, the telephone number that the user must contact to perform periodic maintenance is set.

10.4 HYSTERESIS

Allows to regulate the difference between the “OFF” temperature with respect to the “ON” temperature. It is possible to select a value from $0.1 \div 0.6$.

N.B.: this parameter is only active in the ON/OFF functioning mode (see par. 10.1).

10.5 ASSOCIATION PROCEDURE IN RF.

To carry out an association in radiofrequency between the CRONO 7 and relative Base, follow that reported below:

- 1) Access the protected menu of the CRONO 7 for RF management (radiofrequency): **CODE** via code “9977”;
- 2) The **RF>INS** association/installation menu will appear (if they are not already associated, otherwise the **RF>REM** disassociation menu will appear)
- 3) Within 30 seconds, activate the association stand-by function on the Base by pressing the “**test**” button for at least 4 seconds until the left LED on the base flashes;
- 4) By pressing on the CRONO 7, the **OK** button, the association request starts (**RF>>>> in progress** will appear);
- 5) If the procedure should fail, **RF>INS** will appear on the CRONO 7 again otherwise, if the procedure is successful,

RF>REM will appear with the RF  symbol on and one

or more signals will appear on the Base every 6 secs.

- 6) At the end of the association procedure, power the boiler and wait about 30 seconds before regulation, in a way that the communication between CRONO 7 Base and boiler has established.

10.6 RF DISASSOCIATION PROCEDURE.

To carry out a disassociation in radiofrequency between the CRONO 7 and relative Base, follow that reported below:

- 1) Access the protected menu of the CRONO 7 for RF management (radiofrequency): **CODE** via code “9977”;
- 2) By pressing the **OK** button, the **RF>REM** disassociation/removal menu will appear (if they are associated, otherwise the **RF>INS** association menu will appear)
- 3) Press the **OK** button on the CRONO 7;
- 4) **RF>INS** will appear to indicate disassociation/removal has taken place.

11. CRONO 7 BASE TEST PROCEDURE.

It is possible to force the central heating request directly from the Base of the CRONO 7. To do this, press the button (ref. 2 fig. 9) for 2 seconds. The request at the appliance has duration of 30 seconds, after which the Base will go back to normal functioning status.

12. REPLACE THE BATTERIES.

If the batteries must be replaced on both the devices, first replace those in the Base and then the CRONO 7.

12.1 CRONO 7 Base

When the flashing  symbol is shown on the CRONO 7 display, the Base batteries must be replaced. Proceed as follows to make this replacement:

- Release the bottom from the lid of the CRONO 7 Base, by pressing the sides of the lid with force (fig. 25).
- Pull the lid manually outwards to separate it from the bottom.
- Replace the batteries, making reference to fig. 5.
- At the end, fix the CRONO 7 Base lid to the support bottom, engaging it using pressure.

12.2 CRONO 7

When the fixed  symbol is shown on the CRONO 7 display, the CRONO 7 batteries must be replaced as described below:

- Open the door (ref. 1 fig.8), remove the battery compartment lid (ref. 2 fig.8) and replace the batteries (ref. 5 fig.8).

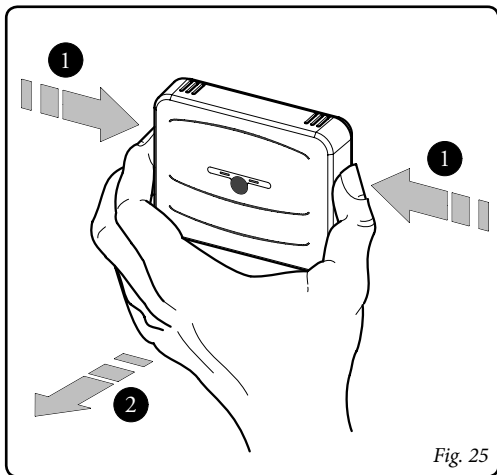

Fig. 25

13. TECHNICAL CHARACTERISTICS

13.1 CRONO 7 Base

- Base Dimensions (LxAxD):..... 105 x 82 x 26 (mm)
- Base Power Supply:..... 2 x 1.5 V, AA batteries
- Duration of the batteries:..... 1 year (with normal use)
- Actuation: Relay with potential free contact: 5 V / 250 VAC, 5A
- RF communication: backbone 868,4 MHz, GFSK modulation, cover 30-100 m (depending on the environment)
- Power and duty cycle:..... Power Tx < 10 dBm, duty cycle < 0.1%in one hour (in normal functioning mode)
- Functioning room temperature: 0 - +50°C (recommended < 40°C)
- Connection technique:..... 2 non-polarised wires
- Connection cable max. length: 50 m (with cable of 2x0.75mm²) (0.5 ÷mm² min - 1.5 mm² max)

13.2 CRONO 7

- CHRONO Dimensions (LxHxD):..... 142 x 103 x 31 (mm)
- Power Supply:..... 2 x 1.5 V, AA batteries
- Functioning room temperature: 0 - +40°C
- Warehouse temperature: -10 - +50°C
- Protection rating according to EN 60730:..... II
- Protection rating according to EN 60529:..... IP 20
- Precision indication room temp.: +/- 0.5°C at 25°C*
- NTC room temp. sensor: 50 k at 25°C
- Clock indication diversion +/- 15 minutes/year

* = the indication of the room temperature can be affected by the point of installation of the CRONO 7 (e.g. hot wall, cold wall, height from the ground, etc.).

13.3 Product specifications.

In accordance with Regulation 811/2013 the temperature control device class is:

Class	Contribution to the environmental heating seasonal energy efficiency	Description
IV	+2%	Wireless weekly digital chronothermostat
VII	+3,5%	Wireless weekly digital chronothermostat coupled to outer sensor

14. FACTORY SETTING

- Functioning state Off
- Functioning program Manual
- Central heating Comfort temperature 20.0°C
- Central heating Economy temperature 16.0°C
- Cooling Comfort temperature 25.0°C
- Cooling Economy temperature 40.0°C
- Room temperature in manual 20.0°C
- Anti-freeze 5.0°C
- Holiday Program VACANZ = OFF
- Building inertia dimension DIMENS = 10
- Room Probe AMB = ON
- Reading Correction AMB CR = 0.0°C
- Chiller CHILL = OFF
- Hysteresis HYSTER = 0,3°C
- Modulation MODUL = OFF
- Telephone control REMOTO = ON
- Language: LINGUA = ITA (Italian)

